

NIV 320B

Induction Hob Instruction Manual



CONTENTS

IMPORTANT SAFETY INSTRUCTIONS	p.3-8
SAFEGUARDING THE ENVIRONMENT	p.8
BEFORE USE	p.8
COOKWAVE	p.8
DESCRIPTIONS OF PRODUCT	p.9
DESCRIPTIONS OF CONTROL PANEL	p.10
INSTALLATION	p.10
ELECTRICAL CONNECTION	p.12-13
INSTRUCTIONS FOR USE	p.13-16
CLEANING	p.17
TROUBLESHOOTING GUIDE	p.17
POWER LEVEL TABLE	p.18

IMPORTANT SAFETY INSTRUCTIONS

READ THESE INSTRUCTIONS CAREFULLY AND COMPLETELY BEFORE USING YOUR APPLIANCE, AND KEEP IT IN A CONVENIENT PLACE FOR REFERENCE WHEN NECESSARY.

THIS MANUAL IS PREPARED FOR MORE THAN ONE MODEL IN COMMON. YOUR APPLIANCE MAY NOT HAVE SOME OF THE FEATURES THAT ARE EXPLAINED IN THIS MANUAL. PAY ATTENTION TO THE EXPRESSIONS THAT HAVE FIGURES, WHILE YOU ARE READING THE OPERATING MANUAL.

General Safety Warnings

- This appliance can be used by children aged from 8 years and above and persons with reduced physical, sensory or mental capabilities or lack of experience and knowledge if they have been given supervision or instruction concerning use of the appliance in a safe way and understand the hazards involved. Children shall not play with the appliance. Cleaning and user maintenance shall not be made by children without supervision.
- **WARNING:** The appliance and its accessible parts become hot during use. Care should be taken to avoid touching heating elements. Children less than 8 years of age shall be kept away

unless continuously supervised.

- **WARNING:** Unattended cooking on a hob with fat or oil can be dangerous and may result in fire. NEVER try to extinguish a fire with water, but switch off the appliance and then cover flame e.g. with a lid or a fire blanket.

- **WARNING:** Danger of fire: do not store items on the cooking surfaces.

- **WARNING:** If the surface is cracked, switch off the appliance to avoid the possibility of electric shock.

- For induction hobs, metallic objects such as knives, forks, spoons and lids should not be placed on the hob surface since they can get hot.

- For induction hobs, after use, switch off the hob element by its control and do not rely on the pan detector.

- For hobs incorporating a lid, any spillage should be removed from the lid before opening. And also the hob surface should be allowed to cool before closing the lid.

- The appliance is not intended to be operated by means of an external timer or separate remote-control system.

- Do not use harsh abrasive cleaners or sharp metal scrapers to clean the oven door glass and other surface since they can scratch the surface, which may result in shattering of the glass or damage to the surface.

- Do not use steam cleaners for cleaning the appliance.

- Your appliance is produced in accordance with all applicable local and international standards and regulations.

- Maintenance and repair work must be made only by authorized service technicians.

Installation and repair work that is carried out by unauthorized technicians may endanger you. It is dangerous to alter or modify the specifications of the appliance in any way.

- Prior to installation, ensure that the local distribution conditions (nature of the gas and gas pressure or electricity voltage and frequency) and the requirements of the appliance are compatible. The requirements for this appliance are stated on the label.

- **CAUTION:** This appliance is designed only for cooking food and is intended for indoor domestic household use only and should not be used for any other purpose or in any other application, such as for non-domestic use or in a commercial environment or room heating.

- All possible security measures have been taken to ensure your safety. Since the glass

may break, you should be careful while cleaning to avoid scratching. Avoid hitting or knocking on the glass with accessories.

- Ensure that the supply cord is not wedged during the installation. If the supply cord is damaged, it must be replaced by the manufacturer, its service agent or similarly qualified persons in order to prevent a hazard.

Installation Warnings

- Do not operate the appliance before it is fully installed.

- The appliance must be installed by an authorized technician and put into use. The producer is not responsible for any damage that might be caused by defective placement and installation by unauthorized people.

- When you unpack the appliance, make sure that it is not damaged during transportation. In case of any defect; do not use the appliance and contact a qualified service agent immediately. As the materials used for packaging (nylon, staplers, styrofoam...etc) may cause harmful effects to children, they should be collected and removed immediately.

- Protect your appliance against atmospheric effects. Do not expose it to effects such as sun, rain, snow etc.

- The surrounding materials of the appliance (cabinet) must be able to withstand a temperature of min 100°C.

- The temperature of the bottom surface of the hob might rise during the operation.

Therefore, a board must be installed underneath the product.

During usage

- Do not put flammable or combustible materials, in or near the appliance when it is operating.

- Do not leave the cooker while cooking with solid or liquid oils. They may catch fire on condition of extreme heating. Never pour water on to flames that are caused by oil.

Cover the saucepan or frypan with its cover in order to choke the flame that has occurred in this case and turn the cooker off.

- Always position pans over the centre of the cooking zone, and turn the handles to a safe position so they cannot be knocked or grabbed.

- If you will not use the appliance for a long time, plug it off. Keep the main control switch off. Also when you do not use the appliance, keep the gas valve off.

- Make sure the appliance control knobs are always in the "0" (stop) position when it is not used.

During cleaning and maintenance

- Always turn the appliance off before operations such as cleaning or maintenance. You can do it after plugging the appliance off or turning the main switches off.

- Do not remove the control knobs to clean the control panel.

TO MAINTAIN THE EFFICIENCY AND SAFETY OF YOUR APPLIANCE, WE RECOMMEND YOU ALWAYS USE ORIGINAL SPARE PARTS AND TO CALL ONLY OUR AUTHORIZED SERVICE AGENTS IN CASE OF NEED.

SAFEGUARDING THE ENVIRONMENT

Scrapping the product

By ensuring this product is disposed of correctly, you will help prevent potential negative consequences for the environment and human health, which could otherwise be caused by inappropriate waste handling of this product.

Energy saving tips

For optimum results, it is advisable to:

- Use pots and pans with bottom width equal to that of the cooking zone.
- Only use flat-bottomed pots and pans.
- When possible, keep pot lids on during cooking.
- Use a pressure cooker to save even more energy and time.
- Place the pot in the middle of the cooking zone marked on the hob.

BEFORE USE

IMPORTANT: The cooking zones will not switch on if pots are not the right size. Only use pots bearing the symbol "INDUCTION SYSTEM" . Place the pot on the required cooking zone before switching the hob on.

COOKWAVE

- Use thick cookware with flat and smooth bottom. Cookware with same diameter as the cooking zone will help reduce cooling times.
- Cookware made of enameled steel or aluminum or copper bottoms can cause a metallic residue on the glass. Clean the hob after every use.
- Use a magnet to check if the pot is suitable for the induction hob: pots and pans are unsuitable if not magnetically detectable.
- Cookware must be placed centrally on the cooking zone in order to work properly.
- When using certain pans, you may get various noises from the pans, this is due to the design of the pans and does not affect the performance or safety of the hob.

- The minimum cookware diameter that elements can detect are Q110mm for 160mm - 210mm hobs and Q160mm for 290mm hob. Cooking performance improves with the increase of the diameter.

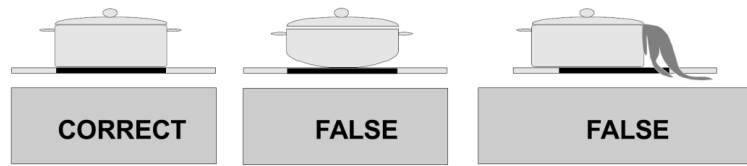

DESCRIPTIONS OF PRODUCT

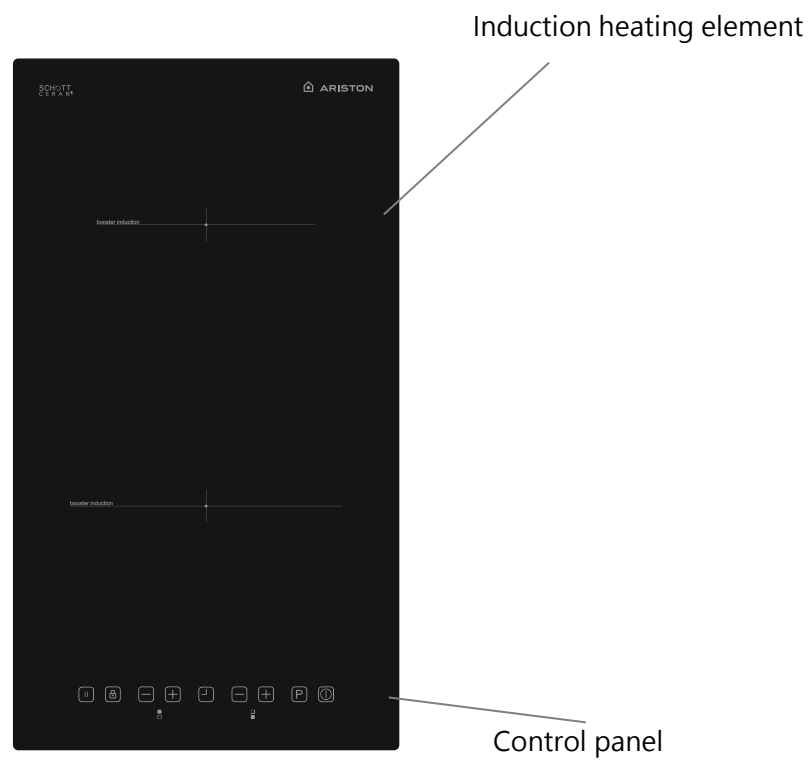

DESCRIPTIONS OF CONTROL PANEL

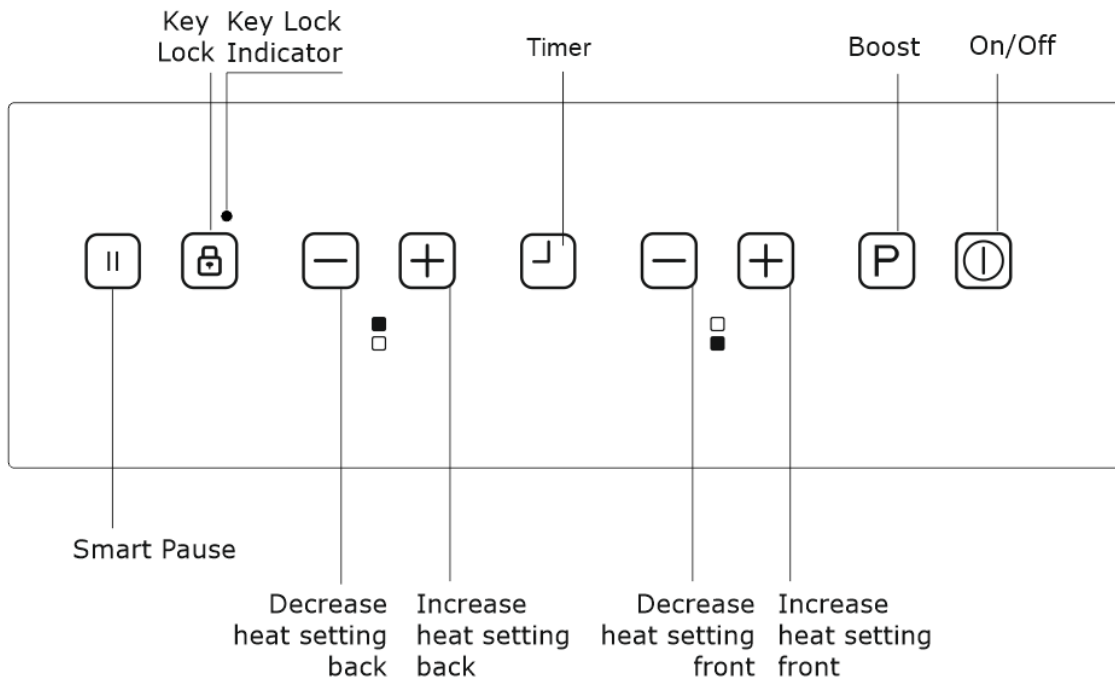

INSTALLATION

After unpacking the product, check for any damage during transport. In the event of problems, contact the dealer or the Whirlpool After-Sales Service.

⚠ WARNING

- The electrical connection of this hob must be carried out by qualified technician, according to the instructions in this user manual and in compliance with the local regulations. In the event of any damage that occurs as a result of improper connection or installation, the warranty will not be valid.

- This appliance must be earthed.

Installation Safety

- Cookerhood needs to be installed at least 65cm above the hob.
- Extractor fans must be fitted in accordance with the manufacturer's instructions.
- The wall in contact with the rear of the hob must be made of flameproof material.

Fitting the hob into a work surface

- The hob can be inserted into any worktop provided it is heat resistant up to at least 90°C.
- Induction hob may be built in 25 to 40mm thick worktops.
 - Create an opening with the dimension shown in the pictures below.

Installation

1. Apply the one-sided self-adhesive sealing tape supplied all the way round the lower glass edge of the cooking surface along the outer edge of the ceramic glass panel. Do not stretch it.
2. Screw the 4 worktop mounting brackets on the side walls of product as picture shown below.

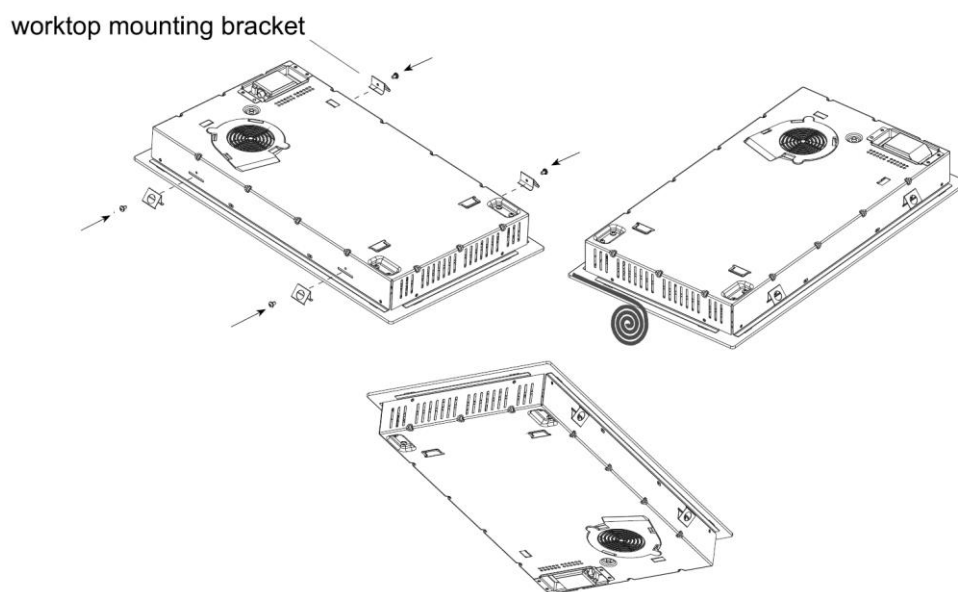

3. Secure the hob in place by putting it into cutout on the work surface.
When installed above oven, it is necessary to remove the rear kitchen element panel in the area of the oven opening, in order to supply ventilation. Also, the front part of the kitchen element must have an opening of no less than 5 mm tall.

W (mm)	290	min. A (mm)	50
D (mm)	520	min. B (mm)	50
H (mm)	56	E (mm)	100
C1 (mm)	270	min. F (mm)	64
C2 (mm)	490	G (mm)	20

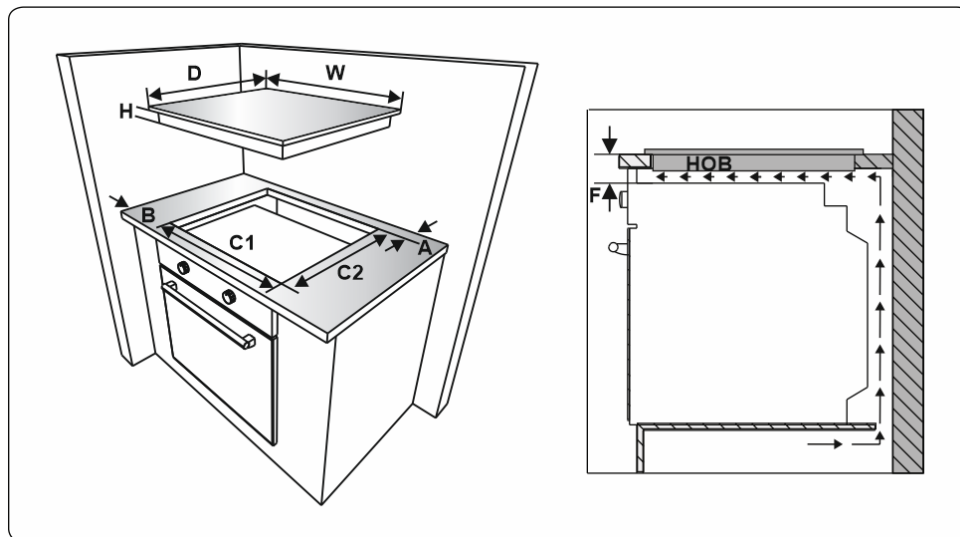
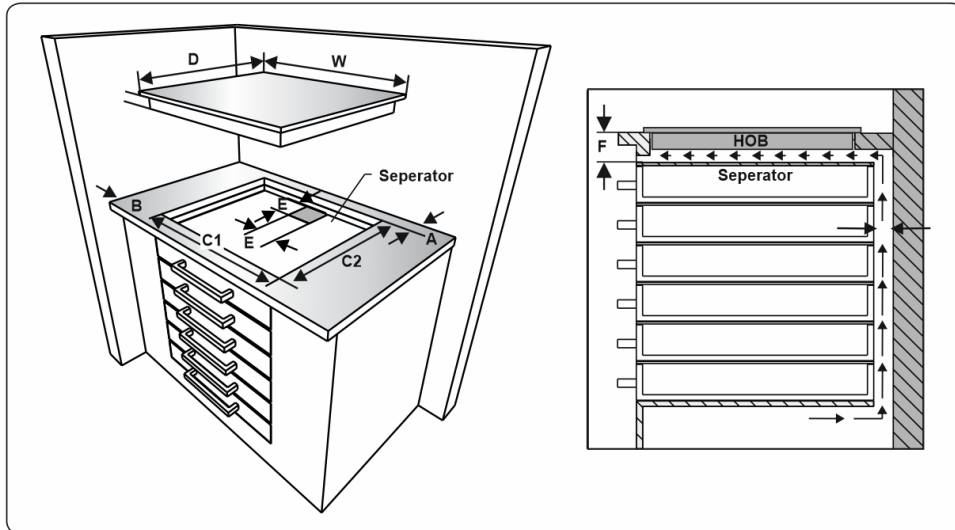

ELECTRICAL CONNECTION

⚠ WARNING

- Disconnect the appliance from the power supply.
- Installation must be carried out by qualified personnel who know the current safety and installation regulations.
- The manufacturer declines all liability for injury to persons or animals and for damage to property resulting from failure to observe the regulations provided in this chapter.
- The power cable must be positioned away from direct heat sources and long enough to allow the hob to be removed from the worktop.
- Make sure the voltage specified on the data plate located on the bottom of the appliance is the same as that of the home.

For the electrical connection, use an H05VV-F 3X1,5mm² cable as specified in the electrical

connection

diagram below. Electrical connection diagram is located on the bottom of the appliance.

Electrical Connection Diagram

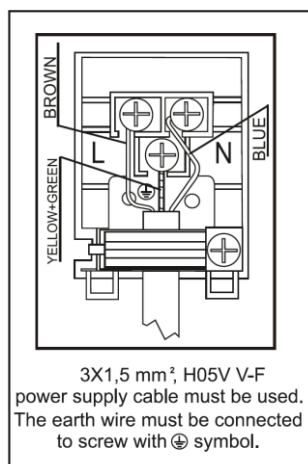

INSTRUCTIONS FOR USE

- Use the induction cooking zones with suitable cookware.
- After mains voltage is applied, all displays are on for a moment. When this time is over, the hob is in the standby mode and it is ready for operation.
- The hob is controlled with electronic sensors which are operated by touching the related sensors. Each sensor activate is followed by a sound signal (**buzzer**).

Switching the hob ON

Switch the hob on by touching the ON/OFF button  until all heater displays show a static "0" and the bottom right dots blink. (If no cooking-zone is selected within 20 seconds, the hob will switch off automatically.)



Switching the hob OFF

Switch the hob off at any time by touching  button.  button always has the priority in the switch off function.



Switching the cooking-zones ON



After switching the hob on and placing the pot on the chosen cooking zone, adjust the power level by

pressing the  button. There is a static dot indication on the selected heater display. Each

cooking zone has various power levels, adjustable with  or  buttons, going from “1”: minimum power, to “9”: maximum power.

Switching the cooking-zones OFF

Select the cooking zone to be switched off by pressing the  button. Press the  button to set the

level to “0”. The cooking zone can also be switched off by pressing the  and  buttons at the same time. The cooking zone switches off and the residual heat indicator “H” lights up. If the cooking zone is hot, “H” will be lighted up instead of “0”.

Booster function

A cooking zone has to be selected, cooking level set to “desired cooking level” and press  button.

 button will be displayed on the corresponding display.

Activating the booster can exceed the maximum power and the integrated power management will be activated.

The necessary power reduction is shown by blinking of the corresponding cooking zone display. It will blink for 3 seconds and power will be adjusted accordingly.

Smart Pause



Smart pause pause the power during cooking process. Power will be resumed to previous cooking level when smart pause is deactivated. If the Smart pause is not de-activated, the cooktop will turn off after 30 minutes

Touch  button to activate smart pause. The power for the activated heater(s) will reduce to level 1 and “II” will appear at all displays.



Touch  button again to deactivate smart pause. “II” will disappear and the heaters will now run at the level previously set.

Child Lock

This function locks the hob controls to prevent accidental switching on. To activate the child lock,

press the  and  buttons simultaneously and then press the  buttons, "L" meaning LOCKED will appear in all displays and the control panel is locked. (If a cooking zone is in hot condition, "L" and "H" will be displayed in alternation.)

The hob will remain in a locked condition, even if the control panel has been switched off and on.

To deactivate the child lock, first switch on the hob, press the  and  buttons simultaneously and then press the  button. "L" will disappear in the display and the hob will be switched off.

Key Lock



Key lock functionality is for blocking and set the appliance into save mode during operation. Adjusting power level is prohibited when key lock is activated. Only ON/OFF button is allowed in this mode. Press  button for 2 seconds to activate the key lock and an acoustic signal sound and the key lock indicator flashes and the heater is locked.

Timer (1 to 99mins)

The timer can be used to set cooking time for each zone. Select the cooking zone to be used with the timer, then select the desired temperature setting and set the desired cooking time by pressing the  button. LED located around the timer indicated which timer has been activated. 10 seconds after the set time has elapsed, an acoustic signal sounds and the timer display changes to the timer that will run out next (in case of programming more than 1 cooking zone.) or timer display shows "00" statically, the assigned cooking zone timer LED blinks when no other timer is set..The programmed cooking zone will be switched off and the "H" will be displayed if the cooking zone is hot. The sound signal and the blinking of the timer LED will be stopped automatically after 30 seconds and/or by operating any button.



Minute minder (1 to 99mins)

The minute minder can be used if the cooking zones are switched off. The timer display shows "00" with a blinking dot.

Press the  button to increase the time or press the  button to decrease the time

between 0 to 99 minutes. If there is no operation in 10 seconds, the minute minder will be sent and the blinking dot will disappear.

Once the set time has elapsed, an acoustic signal sounds and the display blinks and timer begins the countdown. Acoustic signal will sound for 30 seconds or be stopped by pressing any button.

The minute minder can be changed or switched off any time by pressing  or  button.

Switching off the hob by pressing  button at any will also switch off the minute minder.

Residual heat indicator

Residual heat indicator indicates that the cooking zone is still hot

After switching off the cooking zone, the respective display shows “H” until the assigned cooking zone cools down

Safety switch off function

Each cooking zone will be switched off after a defined maximum operation time if the heat setting is not modified. Every change in the cooking zone puts back the maximum operation time to the initial value of the operating time limitation. The maximum operation time depends on the selected temperature level.

Heat Setting	Safety Switch Off After
1-2	6 Hours
3-4	5 Hours
5	4 Hours
6-9	1.5 Hours

Buzzer

While the hob is in operation, the following activities will be signaled by means of a buzzer:

- Normal button activation with a short sound signal
- Continuous operation of buttons over a longer period of time (10 seconds) with a longer, intermitted sound signal.

CLEANING



WARNING

- Do not use steam cleaners.
- Before cleaning, make sure the cooking zones are switched off and that the residual heat indicator "H" is not displayed.

IMPORTANT: Do not use abrasive sponges or scouring pads. Their use could eventually ruin the glass.

- After each use, clean the hob (when it is cool) to remove any deposits and stains due to food residuals.
- Sugar or foods with a high sugar content damage the hob and must be immediately removed.
- Salt, sugar and sand could scratch the glass surface.
- Use a soft cloth, absorbent kitchen paper or a specific hob cleaner (follow the Manufacturer's instructions).

TROUBLESHOOTING GUIDE

- Read and follow the instructions given in the section "IMPORTANT SAFETY INSTRUCTIONS" .
- Make sure there is not a power outage.
- Dry the hob thoroughly after cleaning it.
- If, when the hob is switched on, alphanumeric codes appear on the display, consult the following table for instructions.
- If the hob cannot be switched off after using it, disconnect it from the power supply.

If there is an error, error code will be showed at the heater displays.

ERROR CODE	POSSIBLE CAUSES	ERROR ELIMINATION
E1	Cooling Fan is disabled	Contact Whirlpool After Sale Service
E3	Supply voltage is over than rated values	Turn the hob off, wait until "H" disappears for all zones and then turn the hob on. If same error is appeared again, contact Whirlpool After Sale Service
E4	Supply frequency is different from rated values	Turn the hob off, wait until "H" disappears for all zones and then turn the hob on. If same error is appeared again, disconnect the hob from the mains supply and connect it again. If same error is still appeared, contact Whirlpool After Sale Service
E5	Hob inside temperature is too high	Turn the hob off and wait for hob to cool down.
E6	Communication error between touch control and heater	Contact Whirlpool After Sale Service
E7	Coil temperature sensor is disabled	
E8	Cooler temperature sensor is disabled	
E9	Calibration error	

POWER LEVEL TABLE

The information given in below table is for reference.

Power level		Type of cooking	Level use (Indicating cooking experience and habits)
Max. power	Boost	Fast heating	Ideal for rapidly increasing the temperature of food to fast boiling in the case of water or rapidly heating cooking liquids
	8-9	Frying - boiling	Ideal for browning, starting to cook, frying deep frozen products, fast boiling
High power	7-8	Browning - sautéing - boiling - grilling	Ideal for sautéing, maintaining a lively boil, cooking and grilling (for a short period of time, 5-10 minutes)
	6-7	Browning - cooking - stewing - sautéing - grilling	Ideal for sautéing, maintaining a light boil, cooking and grilling (for a medium period of time, 10-20 minutes), preheating accessories
Medium power	4-5	Cooking - stewing - sautéing - grilling	Ideal for stewing, maintaining a gentle boil, cooking (for a long period of time). Creaming pasta
	3-4	Cooking - simmering - thickening - creaming	Ideal for long-cooking recipes (rice, sauces, roasts, fish) with liquids (e.g. water, wines, broth, milk), creaming pasta
	2-3		Ideal for long-cooking recipes (less than a litre in volume: rice, sauces, roasts, fish) with liquids (e.g. water, wines, broth, milk)
Low power	1-2	Melting - defrosting - keeping food warm - creaming	Ideal for softening butter, gently melting chocolate, thawing small products and keeping just-cooked food warm (e.g. sauces, soups, minestrone)
	1		Ideal for keeping just-cooked food warm, for creaming risottos and for keeping serving dishes warm (with induction-suitable accessory)
OFF	Zero power	Support surface	Hob in stand-by or off mode (possible end-of-cooking residual heat, indicated by an "H")



The symbol on the product or on its packaging indicates that this product may not be treated as household waste. Instead it shall be handed over to the applicable collection point for the recycling of electrical and electronic equipment. By ensuring this product is disposed of correctly , you will help prevent potential negative consequences for the environment and human health, which could otherwise be caused by inappropriate waste handling of this product. For more detailed information about recycling of this product, please contact your local city of fice, your household waste disposal service or the shop where you purchased the product.



Declaration of conformity

We declare that our products meet the applicable European Directives, Decisions and Regulations and the requirements listed in the standards referenced.